

CS 6520

TWO-WAY COLUMN SPEAKER



MAIN APPLICATIONS

- Audio visual applications
- Auditorium
- Halls
- Churches
- Cathedrals
- Meeting places

DESCRIPTION

CS 6520 is a compact two-way column loudspeaker. Its horizontal coverage angle (100°) and its vertical dispersion (40°) allow a proper sound reproduction in wide spaces and help get a better speech intelligibility. It incorporates four 80 mm (3.15") extended-range woofers and a 20 mm (0.79") dome tweeter. It is equipped with a line transformer, which allows direct connections to 70 – 100 V constant voltage lines. When connect to a 100 V line, its power can be selected among the values 20 – 10 – 5 – 2.5 W. CS 6520 is intended for both indoor and outdoor installations.

MAIN FEATURES

- four rubber surround 3.15" woofers
- 0.79" dome tweeters
- 20 / 40 Watt (RMS/Music Power)
- 250 Hz ÷ 20 kHz
- 105 dB (1 m / POWER MAX) max. SPL
- 70 – 100 V multi-tap transformer included
- Crossover frequency: 3500 Hz
- Easy to install
- Simple power settings

SPECIFICATIONS

Loudspeaker	Woofers 4 x 3.15" neodymium magnet, 1 x 0.79" dome
Power (on 8 Ohm load)	20/ 40 W (RMS / Music power)
Power	20 W - 10 W - 5 W - 2.5W (100V)
Sensitivity	92 dB (1 W / 1 m)
Mx. SPL	105 dB(A) (1 m / POWER MAX)
Frequency Response	250 Hz – 20 kHz
Angle of coverage	190° / 130° / 100° @ 1 / 2 / 4 kHz (hor.)
Connection	through 6 wires
Body colour	signal white, RAL 9003
Main body material	Painted aluminium.
Grill material	Steel
Dimensions (HxWxD)	580 mm x 114 mm x 96 mm
Installation	Orientable support included
Max wall distance	88 mm
Net weight	4.2 kg
Operating temperature	-25° to +55°
Relative humidity	90% non condensing



CS 6520

Response 1W/1m

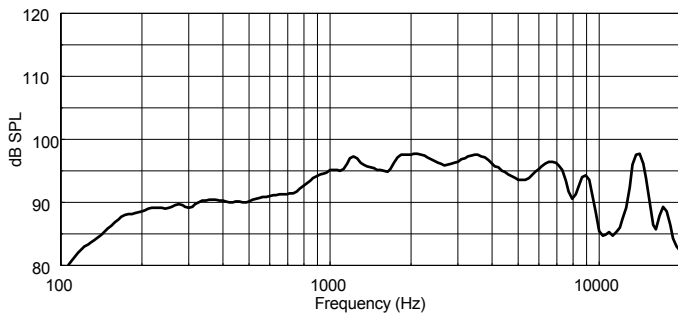

Beamwidth vs. Frequency

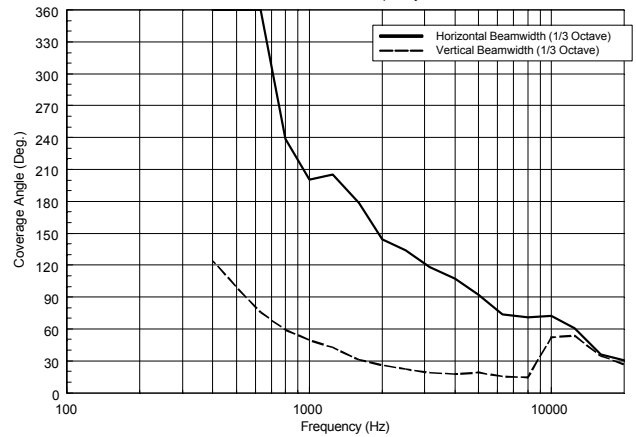

Directivity Index and Q

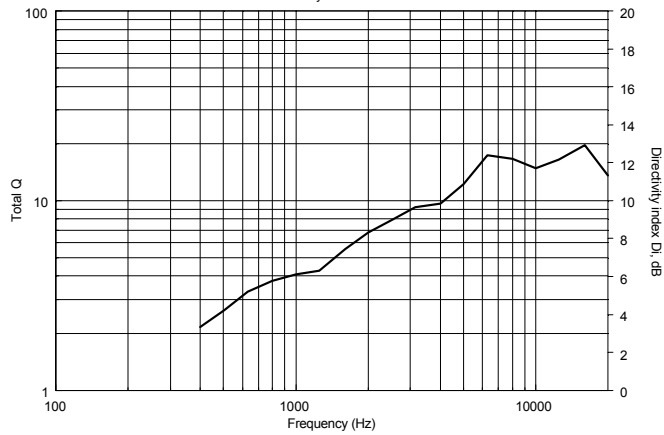

Normalized Horizontal off-axis Response

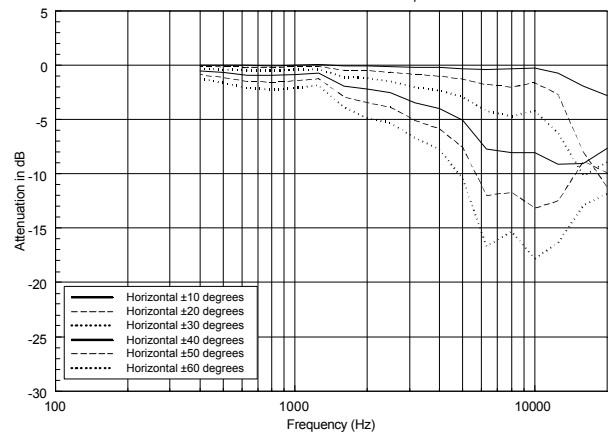

Normalized Vertical off-axis Response

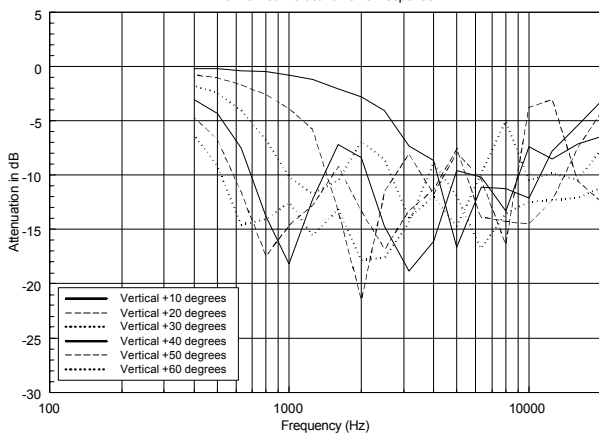

CS 6520

HORIZONTAL 1/3 POLAR PLOT

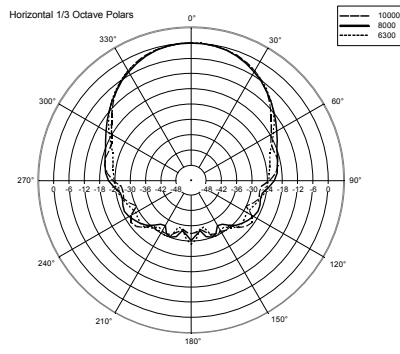
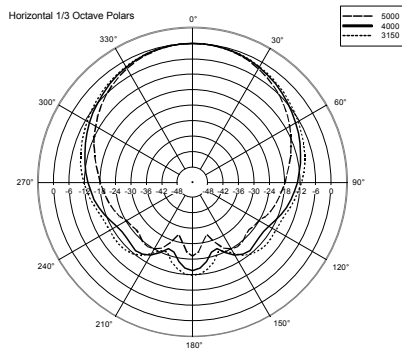
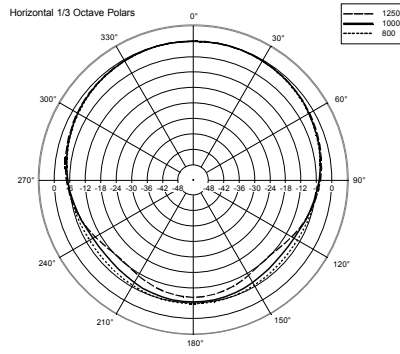
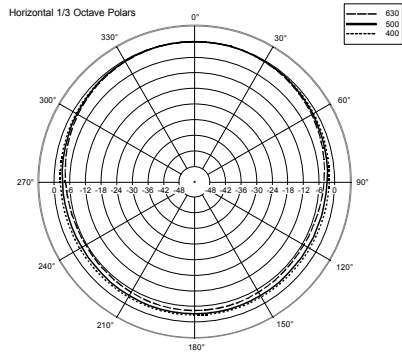

VERTICAL 1/3 POLAR PLOT

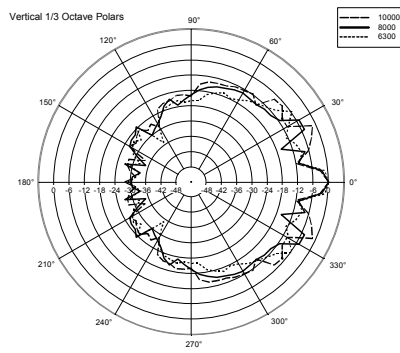
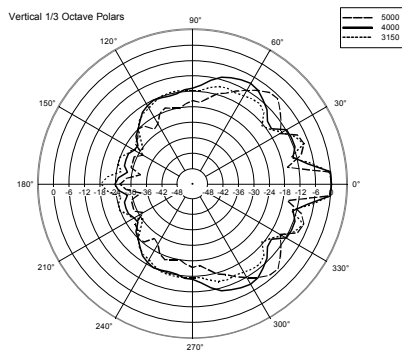
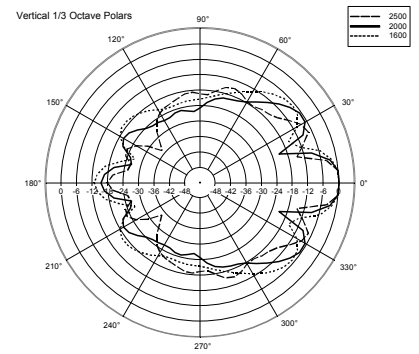
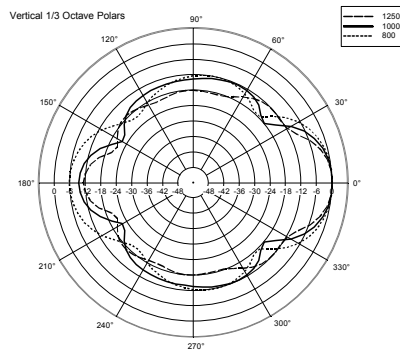
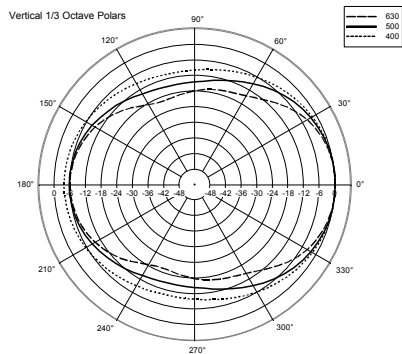

CS 6520

PART NUMBERS

13150005

DIMENSIONS (All data are in mm)

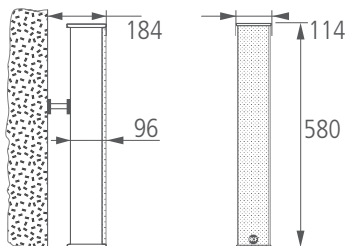

SCHEMATICS

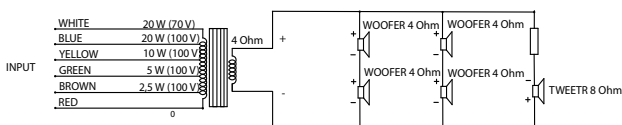

INSTALLATION NOTES

CS 6520 installation is quick and easy thanks to the included accessory that has been designed to keep the column as close as possible to the wall. The 2 support hinges allow to point the column at the desired direction (fixed by using the special Allen wrench to tighten the 2 nuts).

Connections to the loudspeaker line are made by using the six-wire cable (1 metre long) coming out from the loudspeaker rear side.

The enclosure has a body made of extruded aluminium and a robust steel grille.

POWER SELECTION

CS 6520 is equipped with a line multi-tap transformer and can be connected to a 70 – 100 V constant voltage line. The power choice is made by connecting 1 of the 5 wires (and the common one) coming out from the column.

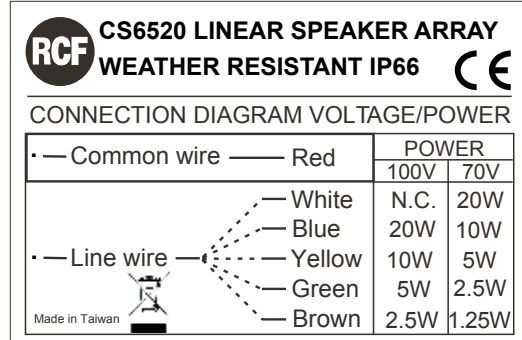

CERTIFICATIONS AND APPROVALS

- CE: it complies with European Community 73/23/EEC and 93768/EEC
- Self-extinguishing plastic according to UL 94V0
- IP rating: 66
- Speaker data according to IEC 268-5
- Electronic apparatus safety requirements according to IEC EN 60065:2002

ACCESSORIES (included)

- Orientable support for wall